

CONTATTORI TETRAPOLARI⁽¹⁾ / FOUR-POLE CONTACTORS⁽¹⁾

GH15FN - GH15GN.4.00 - GH16FN - GH16GN

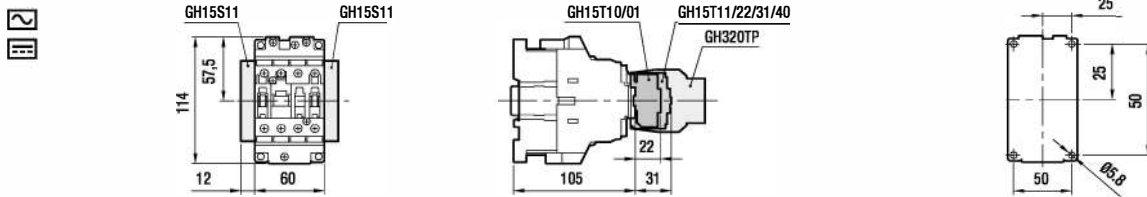

GH15FN - GH15GN - GH16GN.22.00 - GH16GN.04.00 - GH15HN - GH15JN - GH16HN - GH16JN

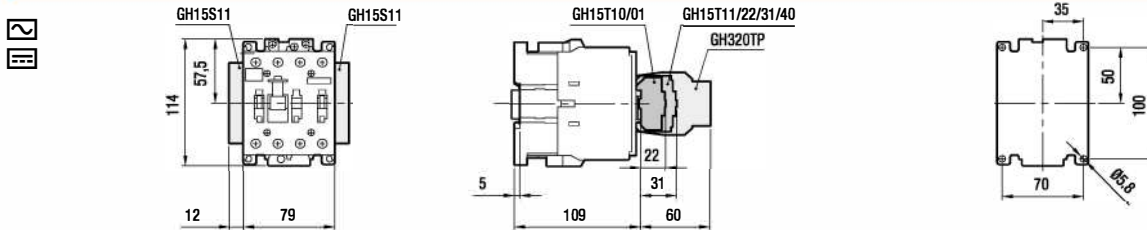

GH15LN - GH16LN - GH15LN.22.00 - GH15LN.04.00 - GH16LN.22.00 - GH16LN.04.00

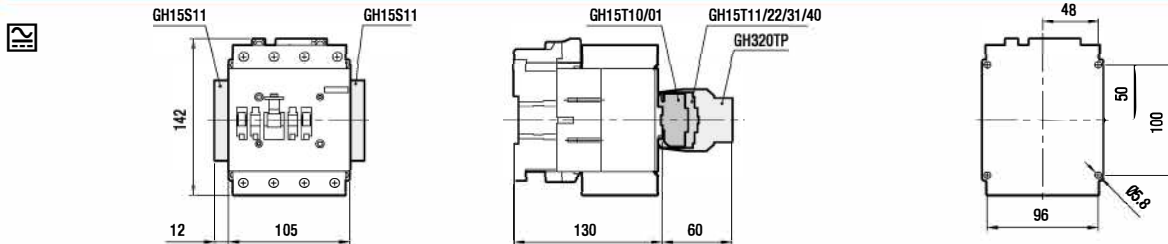

GH15MN - GH15NN - GH15PN - GH16MN - GH16NN - GH16PN

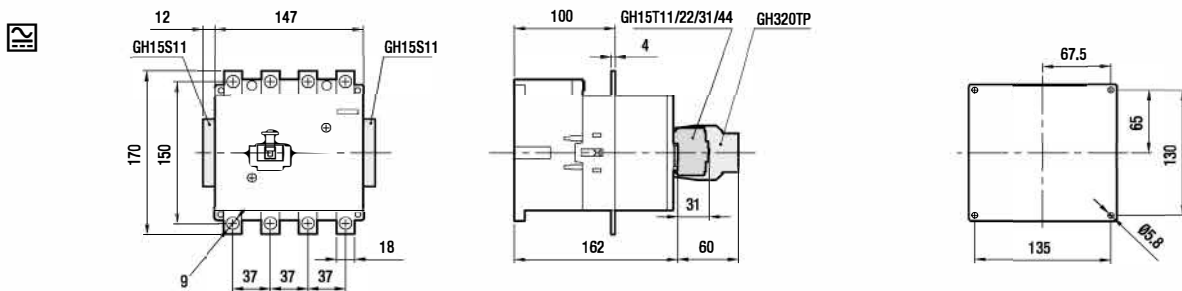

GH15RN - GH15SN - GH15TN - GH16RN - GH16SN - GH16TN

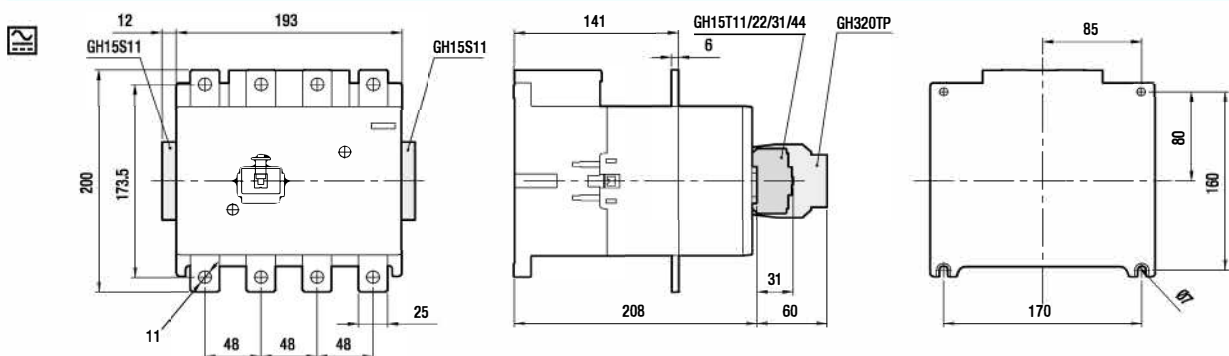

(1): Per contattori GH15BN-GH15CN-GH15DN-GH15EN vedere pag. XX
 (1): For GH15BN-GH15CN-GH15DN-GH15EN contactors see page XX

CONTATTORI TETRAPOLARI⁽¹⁾ / FOUR-POLE CONTACTORS⁽¹⁾

GH16VN

A1.
DIM

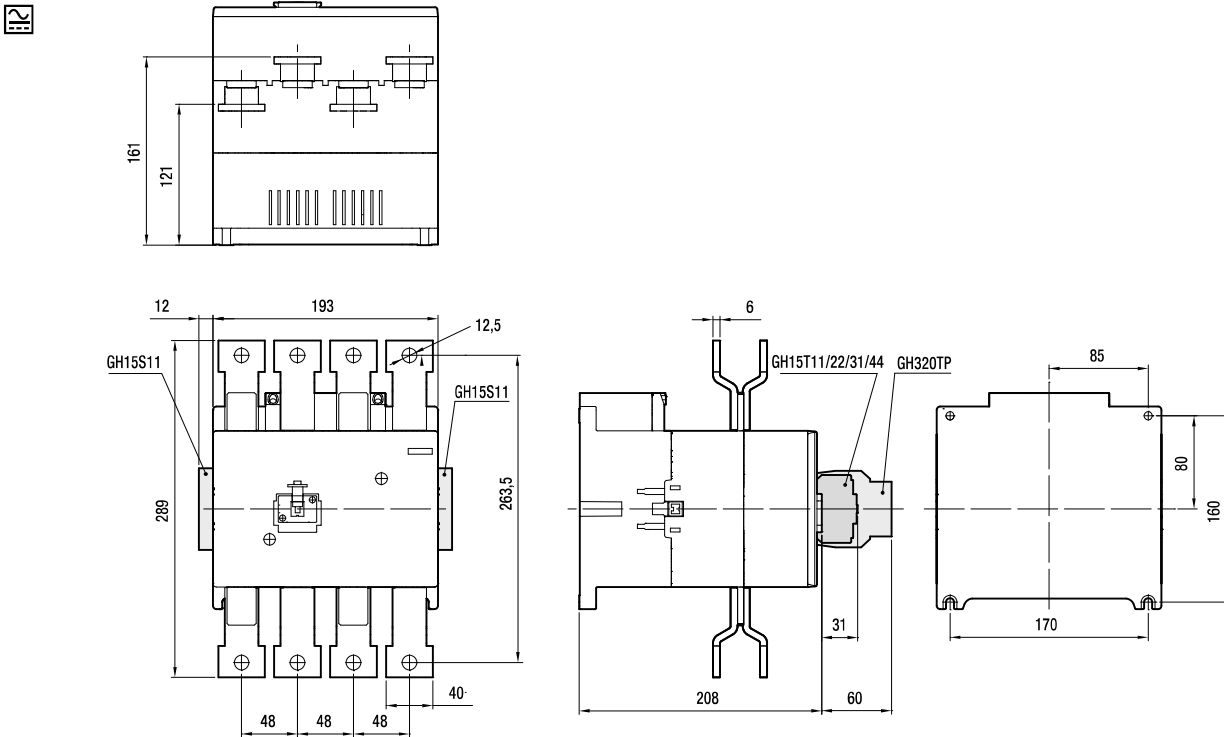

CONTATTORI TRIPOLARI CON IV POLO INTERRUZIONE NEUTRO
THREE-POLE CONTACTORS WITH NEUTRAL SWITCHING POLE

GH55+NP800-5- GH55B+NP800-5- GH57+NP800-5-GH57B+NP800-5- GH62+NP1000-6 - GH62B+NP1000-6
- GH64+NP1000-6

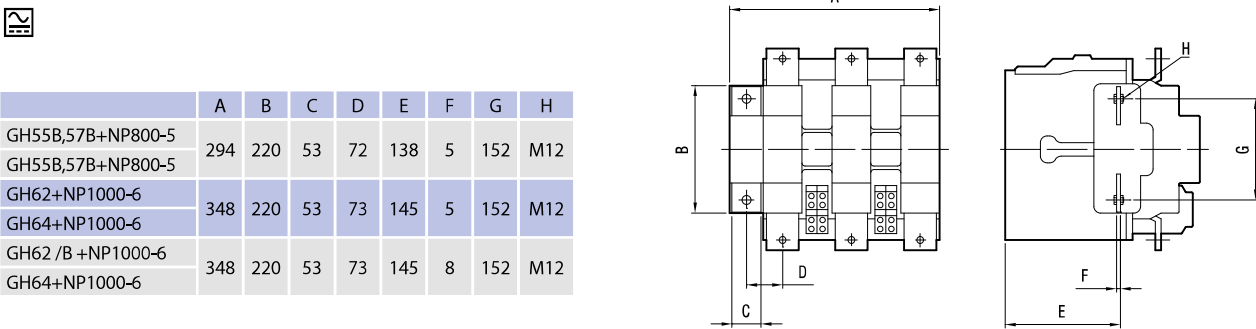

GH76+NP1000-7 – GH78+NP1000-7

